

GRUND CONTACT IN SIMMECHANICS FOR HUMANOID ROBOT

Prof.Asoc.Dr. Likaj R.¹, Prof.Ass.Dr. Bajrami X.², Prof.Asoc.Dr. Shala A*.¹
 Faculty of Mechanical Engineering – University of Prishtina “Hasan Prishtina”, Kosovo¹
 University of Prizren “Ukshin Hoti”, Kosovo²
 ahmet.shala@uni-pr.edu (*corresponding author),

Abstract: this paper deals with the comparison of analysis of two legged humanoid robots during walking. This research area is characterized by the fact that there are a lots of publications, most of which are based on the classic Zero-Moment-Point (ZMP) method. First, a brief overview is provided on humanoid robots, and also models for the dynamic behavior are discussed. As base for these models these two methods Denavit Hartenberg and the Newton-Euler are used. Main aim of this work is to investigate the stability of humanoid robot developed. There is currently the low base of robot - consisting of feet, legs, hips and upper part of robots body. First, the existing low base of humanoid robot was simulated using Matlab / SimMechanics, where the derived by Newton-Euler model was used.

Keywords: KINEMATIC, DYNAMIC, HUMANOID, ROBOT, SIMULINK.

1. Introduction

Simmechanics is a 3D simulation environment that allows to create links, joints and constrains. In this context, it is used to create a 3D model of the humanoid robot for a kinematic simulation. A link is defined by its coordinates, mass and inertia moment matrix. A 3D model can be imported to Simmechanics defining the mechanical properties of the link through the imported file from CAD. Links are connected together through joints. Several joints can be chosen from the library of Simmechanics depending on the degrees of freedom required.

A 3D model of the humanoid robot is required to run a kinematic simulation. Data for joint actuators is imported to simulate the walking. Scopes are used to obtain angle-time plots on each joint, to obtain the ground contact forces and its influence on the trajectory. A rigid multi body system consists of a set of rigid objects, called links, joined together by joints such as introduced in humanoid robots and has been studied in biped locomotion articles (Ibarra, J et al., 2009).

Biped locomotion has been a topic of great attention in a various researches performed on legged robots and is probably the most suitable method for robots to execute assigned maneuvers in a real environment with various obstacle conditions and geometry.

Widespread studies have been conducted on biped walking, and now biped robots are capable of walking with a certain amount of stability. Trajectory control, motion planning and locomotion modeling is completely related to the kinematics analysis as it is fundamental in the study of linkage systems” (McGee, G and Spong, W., 2001)

Forward and inverse kinematics are commonly implemented to determine main parameters affecting humanoid robot behavior and specify the reliable method to control motion and preserve stability (Azevedo, C et al., 2004).

The most frequently practiced parameters to be defined are joint parameters, including required drive torques, angles, and related twists (Murray, R et al., 1994).

The humanoid robot locomotion requires sensible solutions of the inverse kinematics and localization problems with optimized computations. Since the end effector configurations and it is exact

SimMechanics has a number of blocks of physical components, such as body, joint, constraint, coordinate System, actuator, sensor and so on (Li Zheng-wen., 2011). SimMechanics provides a variety of simulation and analysis modes for mechanical systems: Forward Dynamic Analysis-Solve the response to given excitation of the mechanical system; Reverse Dynamic Analysis-Solve the required force and torque according to the results of given movement of the mechanical system; Kinematic analysis-Solve the system's displacement, velocity and acceleration under constraint conditions, and check the consistency; Linear Analysis-Obtain the linear model of the system in the designation of small perturbation or initial state to analyze the system's response performance; Equilibrium point

locations are related to the above mentioned joint parameters with nonlinear characteristics, inverse kinematics problem are usually complicated. For linkages, such joint parameters are a natural default since the correspond directly to the actuation of the joints and are well suited for forward kinematics computations (Christensen, J. et al., 2007)

2. Structure of humanoid robot

A very general schema of the phases of simulation/SimMechanics approach is presented below.

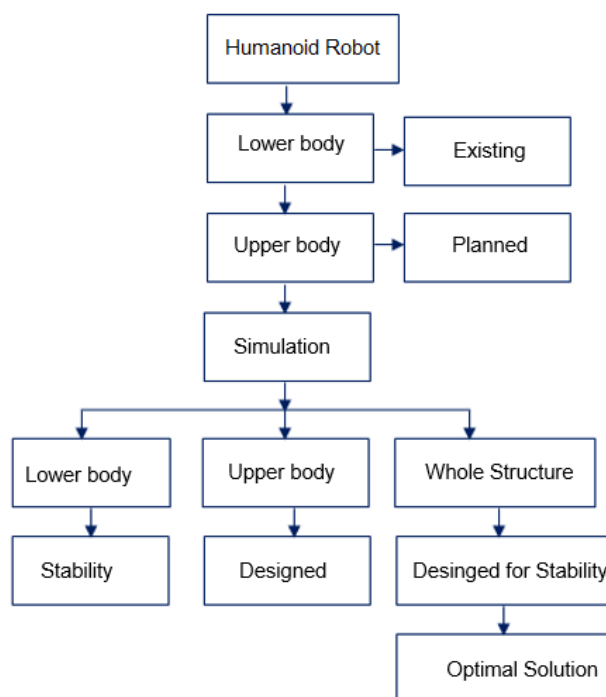

Fig.1 General schema for simulation approach

analysis-Determine the steady-state equilibrium point for system analysis and linear (Ying April, 2012).

This paper deals with modeling of the biped robot's by usage of SimMechanics, and according to simulation experiments to analysis the mechanical structure and sports performance of each part (needs to be reformulated). In order to use the SimMechanics advantages, first we must define the coordinate system of the biped robot.

SimMechanics sets its fixed coordinates in the geometric center of the robot's main body and regards it as the reference coordinate system. Some institutions use indirect coordinate method, that is, according to the coordinates of reference point to describe the location of other joints indirectly. The leg and foot's structure of the

robot is composed of six components: leg bottom, thigh shot, calf of the ends of the lower leg and one of the ends of foot rod are welded together. The following part mainly takes the modeling of leg as an example to describe the modeling process.

First, take the hip joint which is linked with the main body as the primary coverage, and define the direction of rotation of the hip joint. The one end of hip joint is connected with the main body of the robot with a rotating joint, the other one is connected with the leg bottom. In this paper, we set X-axis as the axis of rotation of hip joint to make the leg swing front and rear. The structure of the leg link must take the defined hip joint as a reference. Set X-axis as the axis of rotation of the leg to make it swing up and down.

The model in 3D was build using the already designed model for double foot. For that matter it was necessary to allow motion and calculate the forces in the third dimension. Further, the Archie had to be composed by combining 2 legs, add the physics of the main body, and implement the hip abduction joints between the main body and the legs. The block subsystem (see Fig.2 gray color) contains the whole model of the Archie. On a first level the connection between the main body and the environment an the connection between main body an the legs was modeled (see Fig.2).

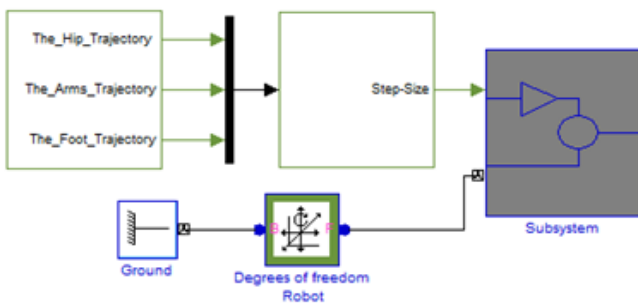

rod, servo motor connecting rod, big calf connecting rod, foot rod. **Fig.2 Model Scheme solution for Archie with simMechanic in 3D**

The angular trajectory error caused by the real robot in case of the movement of the hip joint with different traversing velocities is shown in Fig. 5 and Fig.6. The hip positions (XY direction) are shown in Fig. 3 and Fig.4.

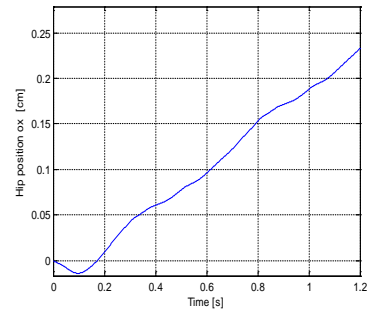

Fig.1 Hip position in direction x

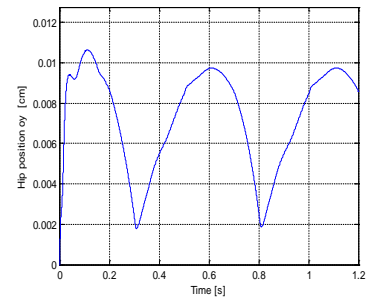

Fig.2 Hip position in direction y

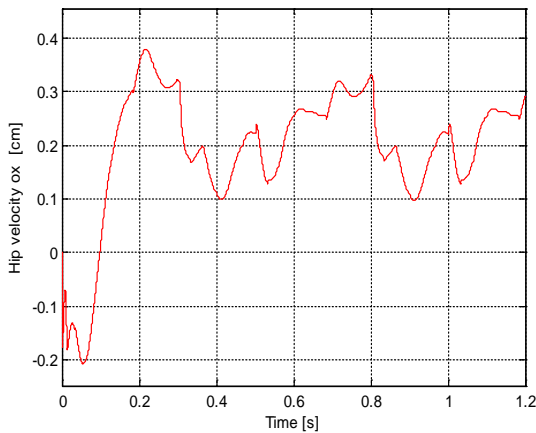

Fig.3 Hip velocity in direction x

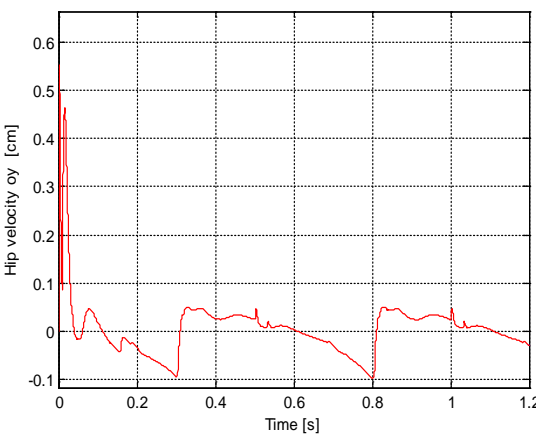

Fig.6 Hip velocity in direction y

3. LOWER DADY IN SIMMECHANICS

Foot-Component: In this subsystem it is designed a model for humanoid robot (left_right-legs, left_right-shins, left_right-foots).

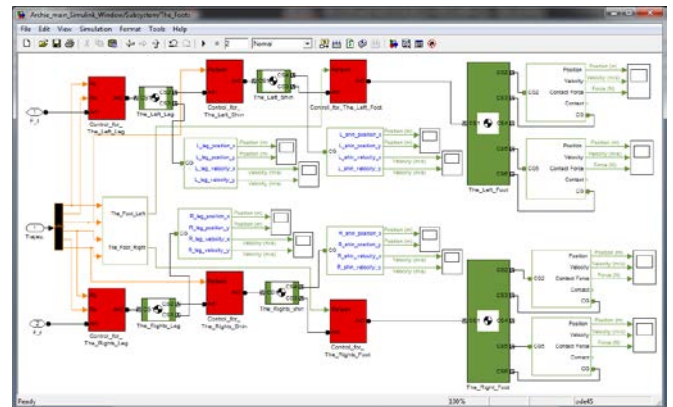
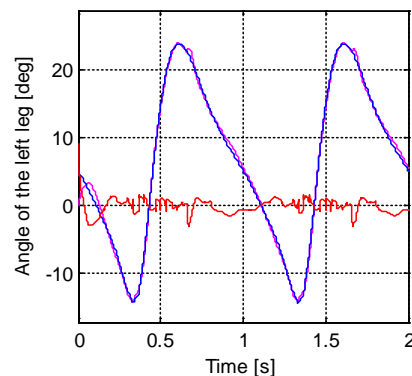

Fig.7 The Subsystem for feet with ground

The angle movement of the leg left join with PID controller is shown in Fig. 8.



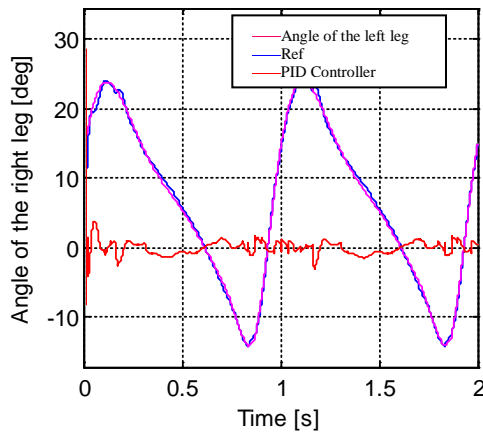

Fig.8: Angle for left leg and right leg with PID controller

Traditional PID and PIV controllers are generally good enough for most motion control applications. The ubiquitous proportional-integral-derivative controller is especially cheap and easy to implement. Tuning PID and PIV controllers is a relatively straightforward operation that can be accomplished with a few empirical tests.

PID controller designed in this work, is a generic control loop feedback mechanism which attempt to correct the error between a measured process variable and a desired set point by calculating and then outputting a corrective action that can adjust the process accordingly, based upon tree parameters (Fig. 9).

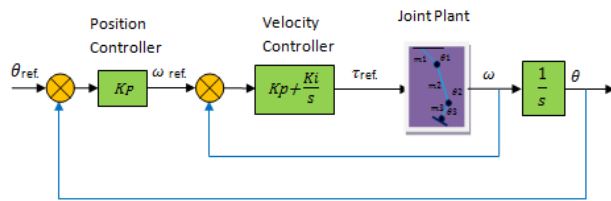

Fig.9 Cascade control

4. Linear Inverted Pendulum Model

The Linear Inverted Pendulum Model was first introduced by Kajita and Tani in 1991 (S. T. Kajita 1991). The main idea of this approach is to extract a dominant feature of biped dynamics, which is high-order and non-linear, and to use this dominant factor to explain the governing dynamics of the system. In this model the robots mass is assumed to be lumped at the center of mass of the robot and the legs of the robot are assumed to be mass (Okan, K., 2006). Further, for simplicity, the height of the pendulum is assumed to be constant in this model. This lets the dynamics of the model to be linear. Such an inverted pendulum with a mass rod can be seen in Fig. 10.

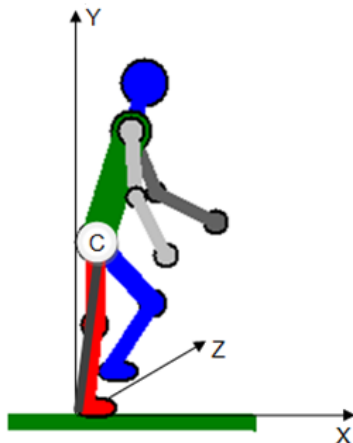

Fig. 10 Inverted pendulum

Where $C = [c_x, c_y, c_z]^T$

The ZMP equations for x – y plane are as follows.

$$x_{zmp} = \frac{\sum_{i=1}^n m_i (\ddot{z}_i - g_i) \cdot x_i - \sum_{i=1}^n m_i (\ddot{x}_i - g_i) \cdot z_i}{\sum_{i=1}^n m_i (\ddot{z}_i - g_i)} \tag{1}$$

$$y_{zmp} = \frac{\sum_{i=1}^n m_i (\ddot{z}_i - g_i) \cdot y_i - \sum_{i=1}^n m_i (\ddot{y}_i - g_i) \cdot z_i}{\sum_{i=1}^n m_i (\ddot{z}_i - g_i)} \tag{2}$$

Where, $P_{ZMP} = [x_{zmp}, y_{zmp}, z_{zmp}]^T$ shows the ZMP vector of any kinematic chain, the gravity vector is $g = [g_x, g_y, g_z]^T$ and $g_z = -g \cdot [x_i, y_i, z_i]^T$ and m_i is the position vector and the mass of each link, respectively.

Now, let the ZMP of coordinates of this pendulum to be $P = [p_x, p_y, p_z]^T$, the mass of the pendulum (CoM) to be m_i . Using the ZMP equation (1) and (2) the dynamics equations of the inverted pendulum can derived as follows.

$$P_x = \frac{m \cdot (\ddot{c}_z + g) \cdot c_x - m \cdot \ddot{c}_x \cdot c_z}{m \cdot (\ddot{c}_z + g)} \tag{3}$$

$$P_y = \frac{m \cdot (\ddot{c}_z + g) \cdot c_y - m \cdot \ddot{c}_y \cdot c_z}{m \cdot (\ddot{c}_z + g)} \tag{4}$$

However equations (3) and (4) are non-linear. To attain equations assume the z-coordinates of the inverted pendulum is assumed to be constant, let $c_z = z_c$.

The equations (3) and (4) can be linearized

$$\left. \begin{aligned} P_x &= c_x - \frac{\ddot{c}_x}{\omega_n^2} \\ P_y &= c_y - \frac{\ddot{c}_y}{\omega_n^2} \end{aligned} \right\} \tag{5}$$

Where $\omega_n^2 = \frac{g}{z_c}$

Henceforth, (5) is going to be referred as ZMP equations. Note that given the Center of Mass (CoM) coordinates of the pendulum $C = [c_x, c_y, c_z]^T$ at any time it is straightforward to calculate the ZMP coordinates of the pendulum by (3) and (4) (Okan, K., 2006). The walking trajectory generation is the inverse problem: Given a ZMP trajectory a corresponding CoM trajectory should be found. Thus, this trajectory of CoM could be used as a reference for the CoM of the actual biped walking robot (Okan, K., 2006). Further the legs should be in such coordination that this CoM is tracked accurately.

Since the goal is to achieve a dynamically stable gait the ZMP trajectory should always lie inside the supporting polygon (Vukobratovic. M. 2007), (Okan, K., 2006). And this actually determines the location of the footprints of the biped robot. Finally by knowing the footprints and the CoM trajectory by inverse kinematics relations a possible gait could be achieved (Suleiman. W. 2011).

A good example in order to have a better insight and intuition on Linear Pendulum Model (LPM) model is the Table-Cart model which is used by Kajita in (S. K. Kajita September 2003). Such a Table-Cart model can be seen in Fig. 50. Actually the governing dynamics of the LIPM is exactly analogous to the Table-Cart model since the height of the pendulum is assumed to be constant.

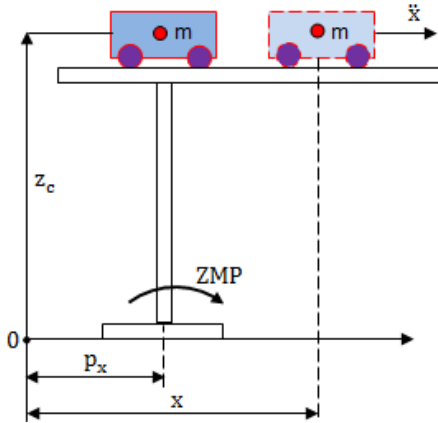

Fig. 114 The Table-Cart model

As depicted in the Fig. 11, assume the cart to be at the position showed by dashed lines. If the cart is not moving then, since the foot of the table is not long enough to equalize the torque generated by the cart, the table would fall eventually. However, if the cart has a proper acceleration, the table can remain upright for a while. At the moment, ZMP lies inside the table foot. Since the moment around the ZMP must be zero the following condition holds.

$$\tau_{ZMP} = mg \cdot (x - p_x) - m \cdot \ddot{x} \cdot z_c$$

5. Solution of Humanoid Linear Pendulum Model for Fixed ZMP

In this section the exact solution of the Linear Pendulum Model (LPM) equations with given fixed ZMP trajectories, (Choi June 2004), is given. Accord to the ZMP equations (5)

$$P_x = c_x - \frac{1}{\omega_n^2} \ddot{c}_x, \quad P_y = c_y - \frac{1}{\omega_n^2} \ddot{c}_y$$

Rearranging these equations,

$$\ddot{c}_x = c_x \cdot \omega_n^2 - P_x \cdot \omega_n^2 \quad (6)$$

$$\ddot{c}_y = c_y \cdot \omega_n^2 - P_y \cdot \omega_n^2 \quad (7)$$

Laplace transform of (6) and (7)

$$C_x(s) = \frac{1}{1 - \frac{1}{\omega_n^2} s^2} \left[p_x(s) - \frac{1}{\omega_n^2} C_x(0)s - \frac{1}{\omega_n^2} \dot{C}_x(0) \right] \quad (8)$$

$$C_y(s) = \frac{1}{1 - \frac{1}{\omega_n^2} s^2} \left[p_y(s) - \frac{1}{\omega_n^2} C_y(0)s - \frac{1}{\omega_n^2} \dot{C}_y(0) \right] \quad (9)$$

In equation (6) and (7) the following fixed ZMP trajectories are going to be used for the exact solution calculation. In Fig.12, the x-axis (for saggital plane) reference for ZMP trajectory. In Fig.12, the y-axis (for frontal plane) reference for ZMP trajectory, and in Fig. 13, the resulting ZMP trajectory in the x-y plane is shown (Okan, K., 2006).

$$p_x - ref = B \sum_{k=1}^{\infty} l(t - kT_0) \quad (10)$$

$$p_y = A l(t) + 2A \sum_{k=1}^{\infty} (-1)^K l(t - kT_0) \quad (11)$$

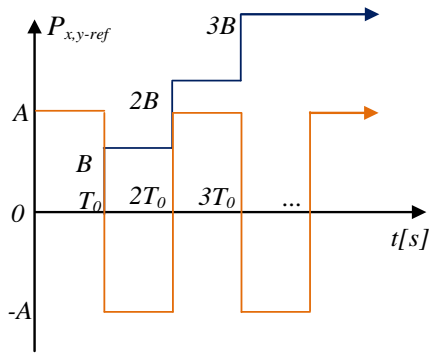

Fig.12 px-ref and py-ref, x-axis and y-axis ZMP reference trajectory (Okan, K., 2006).

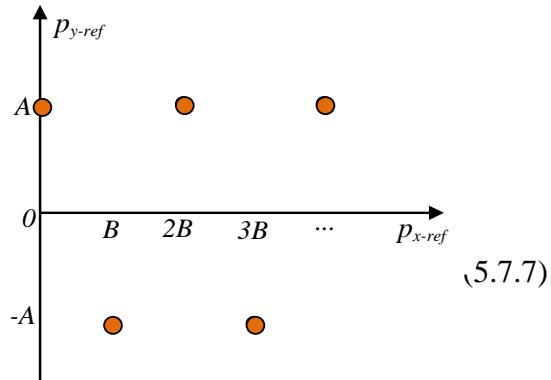

Fig.13 px-ref, py-ref an x-y plane ZMP reference trajectory / Step Positions (Okan, K., 2006).

Laplace transform of equations (10) and (11) and substituting in (3) and (4) with zero initial conditions the following equation can be derived.

Where: $\frac{1}{1 - \frac{1}{\omega_n^2} s^2} = \frac{1}{s} + \frac{s}{(s^2 - \omega_n^2)}$

Equations (5) and (6) can be rearranged to derive the following transfer functions.

$$C_x(s) = A e^{-T_0 s} \left(\frac{1}{s} - \frac{s}{(s^2 - \omega_n^2)} \right) \left[1 - 2e^{-T_0 s} + 2e^{-2T_0 s} + \dots \right] \quad (12)$$

Finally, the exact reference trajectories of the CoM can be obtained by the inverse Laplace transformation of equations (12 and 13).

$$C_x(s) = B(1 - \cosh \omega_n(t - T_0)) l(t - T_0) + \dots + B(1 - \cosh \omega_n(t - 2T_0)) l(t - 2T_0) + \dots \quad (13)$$

$$= B \sum_{k=1}^{\infty} (1 - \cosh \omega_n(t - kT_0)) l(t - kT_0)$$

$$C_y(s) = A(1 - \cosh \omega_n(t - T_0)) l(t - T_0) - \dots + 2A(1 - \cosh \omega_n(t - 2T_0)) l(t - 2T_0) + \dots \quad (14)$$

$$= 2A \sum_{k=1}^{\infty} (1 - \cosh \omega_n(t - kT_0)) l(t - kT_0)$$

Although equation (13 and 14) are the exact solutions for the ordinary differential equation (5) and (6), in practices they are difficult to be used robustly for a real biped walking robot "Archie", they are unstable and very sensitive to the variation of ω_n .

Therefore, an approximated solution composed of bounded sin (.) function is suggested to serve as a robust Center of Mass (CoM) trajectory in the following section (Okan, K., 2006).

The approximate solution for Linear Pendulum Model (LPM) equations, first an odd function with period T_0 is introduced from the x-directional reference ZMP p_x^{ref} of equation (5) as follows.

$$\dot{p}_x(t) = p_x^{ref}(t) - \frac{B}{T_0} \left(t - \frac{T_0}{2} \right) = \frac{B}{T_0} \left(t - \frac{T_0}{2} \right) \text{ and } \dot{p}_x(t+T_0) = \dot{p}_x(t)$$

Assuming that the x-directional reference trajectory of Center of Mass (CoM) can be expressed by a Fourier serie,

$$C_x^{ref}(t) = \frac{B}{T_0} \left(t - \frac{T_0}{2} \right) + \sum_{n=1}^{\infty} \left[\begin{array}{l} a_n \cdot \cos\left(\frac{n\pi}{T_0}t\right) + \\ b_n \cdot \sin\left(\frac{n\pi}{T_0}t\right) \end{array} \right] \quad (15)$$

Applying equation (13) to the ZMP differential equation (14) yields to

$$p_x^{ref}(t) = \frac{B}{T_0} \left(t - \frac{T_0}{2} \right) + \sum_{n=1}^{\infty} \left[\begin{array}{l} a_n \left(1 + \frac{n^2 \pi^2}{T_0^2 \omega_n^2} \right) \cos\left(\frac{n\pi}{T_0}t\right) + \\ b_n \left(1 + \frac{n^2 \pi^2}{T_0^2 \omega_n^2} \right) \sin\left(\frac{n\pi}{T_0}t\right) \end{array} \right] \quad (16)$$

From equation (11) the form of the odd function $p_x(t)$ is shown in Fig.14.

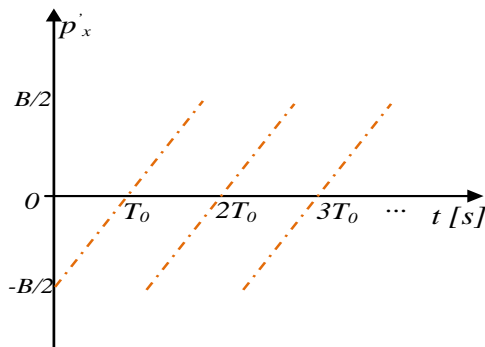

Fig.14 Odd function $\dot{p}_x(t)$ (Okan, K., 2006).

The coefficients $a_n = 0$ and b_n follows from

$$b_n = \frac{B \cdot T_0^2 \cdot \omega_n^2 \cdot (1 + \cos n\pi)}{n\pi \cdot (T_0^2 \omega_n^2 + n^2 \pi^2)} \quad (17)$$

The x-directional reference trajectory of Center of Mass (CoM) can be found by substituting in equation (12) equation (13).

$$C_x^{ref}(t) = \frac{B}{T_0} \left(t - \frac{T_0}{2} \right) + \sum_{n=1}^{\infty} \left[\begin{array}{l} \frac{B \cdot T_0^2 \cdot \omega_n^2 \cdot (1 + \cos n\pi)}{n\pi \cdot (T_0^2 \omega_n^2 + n^2 \pi^2)} \\ \cdot \sin\left(\frac{n\pi}{T_0}t\right) \end{array} \right] \quad (18)$$

In Fig. 15 it can be observed that the new C_x, C_y are smoother than both of the previous versions. This, in fact, is an outcome of the novel approach of embedding both the varying ZMP reference and the double support phases in to Fourier approximation to LPM equations (Okan, K., 2006).. Also it can be observed that the Gibbs Phenomenon effect is almost disappeared and a smoother ZMP reference approximation is achieved.

In Fig. 15 (left) it can be observed that the CoM is passing through acceleration and deceleration phases in such a way that the given ZMP reference is achieved. Similarly in Fig. 15 (right) the CoM is forming a sine-like curve to satisfy the ZMP reference.

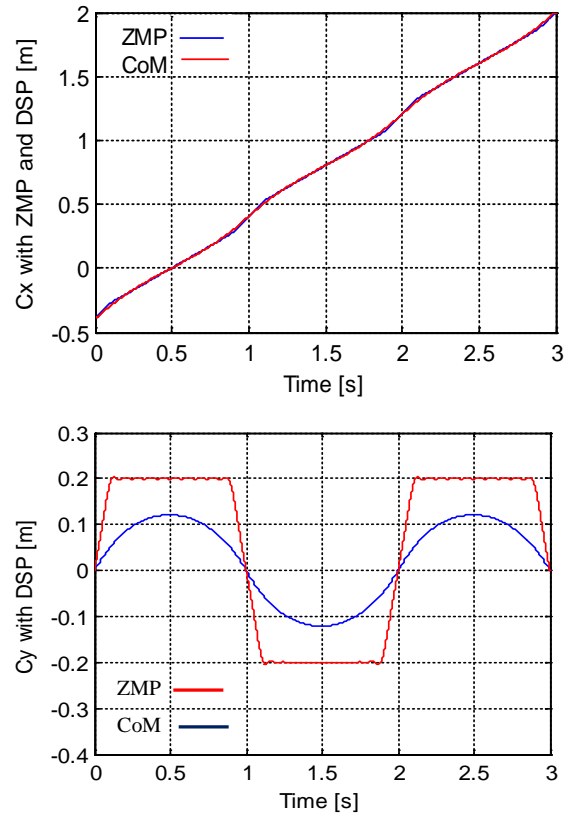

Fig.15 Natural C_x, C_y reference with parameters close to human walk

4. Conclusions

The main goal was the derivation of a walking model for dynamic behavior of a Humanoid robot. For the two different locomotion phases a new approach was created. Both phases are now included in our model on the (very well known) Newton-Euler equations. Using Newton-Euler equations enable the computation of dynamic equations numerically without going through analytical derivation procedure which is unpractical for a complex system with 30 DOF's and to calculate reaction forces and moments between bodies which might be beneficial for the preliminary stage of mechanical design. Based on previous conclusion, mechanical model of humanoid robot for Matlab/Simulink use is done using SimMechanics Toolbox. Complete scheme is represented in Fig. (7). It is important to clarify that using SimMechanics was possible to import parts' design, add of dynamical characteristics e.g. masses, moment of inertia etc., add of different types of sensors e.g. position, velocity and force sensors. Using SimMechanics is realized individual control of joint actuators-motors. Increase of boundaries of stability (ZMP), in this paper is achieved by changing the center of mass of hip (change of fixed position of batteries). For the future work, there are many problems involving the implementation of the simulator and motion planning for a biped robot. The method can use to build simulator in combination with other methods for improving the stability, fields for possible future projects can be: Intelligent control – all control techniques that use various Artificial Intelligence approaches like neural networks, fuzzy logic, machine learning, evolutionary computation and genetic algorithms can be put into the class of intelligent control. New control techniques are created continuously as new models of intelligent behavior and computational methods developed to support them. Complete Control scheme using conventional and non-conventional (Fuzzy Logics and Artificial Neural Networks) controllers, will be necessary and inevitable.

5. References

Azevedo, C., Andreff, N. and Arias, S. Bipedal walking: From gait design to experimental analysis. *Mechatronics* 14 , 639-665, 2004.

Baltes, J., Byagowi, A., Kopacek, P. "A teen Sized Humanoid Robot - Archie." *IJAA*. 2010. 60-71.

Choi, Y., You, B.J., Oh, S.R., "On the Stability of Indirect ZMP Controller for Biped Robot Systems." Japan: Proceedings of International Conference on Intelligent Robots and Systems, pp: 1966-1971, vol.2, Sendai, June 2004

Christensen, J., Nielsen, J. L., Svendsen, M. S. "Development, Modeling and Control of a Humanoid Robot." Aalborg University: Masters thesis, 2007

OKAN, K. "BIPED ROBOT REFERENCE GENERATION WITH NATURAL ZMP TRAJECTORIES ." Sabanci University: Submitted to the Graduate School of Engineering and Natural Sciences in partial fulfillment of the requirements for the degree of Master of Science, 2006

Spong, W.M., Hutchinson, S., and Vidyasagar, M. "Robot modeling control." Wiley New Jersey: ?, 2006.

Kopacek, P. "Cost Oriented Humanoid Robots." 18th IFAC World Congress. Milano: IFAC, 2011

Ying, Xu., Shou, Y.D., Ya, C.L. "Motion Simulation and Analysis of the Biped Robot." University of Yamanashi, 400-8510 Japan: *Advanced Materials Research (Volumes 503 - 504)*, (US\$ 28,- / € 20,-), April, 2012.

LI Zheng-wen., ZHANG Guo-liang., ZHANG Wei-ping JIN Bin. A Simulation Platform Design of Humanoid Robot Based on SimMechanics and VRML. 1877-7058 © 2011 Published by Elsevier Ltd. China: *Procedia Engineering* 15 (2011) 215 – 219, 2011.

Bajrami, Xhevahir, et al. "Modeling and control of a humanoid robot." *e & i Elektrotechnik und Informationstechnik* 130.2 (2013): 61-66.

Ibarra, J., Zannatha, Limon, R. C. "Forward and Inverse Kinematics for a Small-Sized Humanoid Robot." In proceedings of the 19th IEEE International Conference on Electrical, Communications and Computers, 2009

Bajrami, Xhevahir. Dynamic modeling and simulation of a biped robot. PhD Thesis, Vienna University of Technology 2013.

Vukobratovic, M., Juricic, D.: "Contribution to the Synthesis of Biped Gait." *Serbia: IEEE Transactions of Biomedical Engineering*, Vol. 16, No. 1, 1969.

Bajrami, X., et al. "Trajectory Planning and Inverse Kinematics Solver for Real Biped Robot with 10 DOF-s." *IFAC-PapersOnLine* 49.29 (2016): 88-93.

Vukobratovic, M., Potkonjak, V., Babkovic, K., Borovac, B. "Simulation model of general human and humanoid motion." *Multibody System Dynamics* 17 (1) (2007) 71-96., 2007.

Kajita, S., Kahehiro, F., Kaneko, K., Fujiwara, K., Harada, K., Yokoi, K., Hirukawa, H. "Biped Walking Pattern Generation using Preview Control of the Zero-Moment-Point." Taipei, Taiwan: Proceedings of IEEE International Conference on Robotics and Automation, pp: 1620-1626, vol.2, September 2003.

Kajita, S., Tani, K. "Study of Dynamic Bipedal Locomotion on Rugged Terrain-Theory and Basic Experiment." *ICAR*, International Conference on Advanced Robotics, 1991